

Now With More Standard Features

Our essential basic car hauler, the Raven Limited comes ready to roll with more new standard features and everything you need to get your vehicle securely down the road. Raven's lightweight, high-quality aluminum frame is built to exacting standards that ensure it will hold its value for the long haul.



Shown with optional equipment



READY TO GO

Our Raven Limited Car Hauler has new standard features that make it an exceptional value. It's outfitted from the start for hauling your race car, a car-show treasure or motorcycles and ATVs for a weekend outing. Our most popular car hauler, the Raven Limited is a sturdy, dependable way to transport your vehicles. Raven can also be ordered and equipped with optional packages to more precisely fit your needs.

Details and options at AluminumTrailer.com

STANDARD ON RAVEN LIMITED CAR HAULERS:

- Full perimeter aluminum frame with all-tube aluminum construction.
- 16" on-center floor, wall and roof crossmembers.
- Torsion axles and electric brakes on all axles.
- 3/4" engineered subfloor.

(See reverse side for a complete list of features and options.)

BASE MODELS

8.5' x 20' w / 3500#
 8.5' x 20' w/ 5200#
 8.5' x 24' w/ 5200#
 8.5' x 28' w/ 5200#

COLORS

Exterior



Polar White Black Silver Frost Medium Charcoal Light Pewter Metallic

CABINETS

(Cabinets available only with Deluxe Package)

Package 1 - Upper Only - Black

Package 2 - Straight Lower, Upper - Black

Package 3 - L-base Lower, 36x36 Gen Door, Upper - Black

OPTIONS

88" x 66" Premium Escape Door - Removable Wheel Well
 Screwless Aluminum Ceiling - White (Black Cove and Spring Box)
 Insulated Wall and Ceiling - (requires alum ceiling)

STANDARD FEATURES

Frame

Full Perimeter Aluminum Frame
 All-Tube Aluminum Construction
 Extended Tongue
 Torsion Axles
 Electric Brakes - All Axles
 Breakaway Battery Kit
 7-Way Trailer Plug
 2 5/16" Ball Coupler
 Safety Chains
 5000# Manual Crank Jack
 16" O/C Floor Crossmembers
 16" O/C Wall Crossmembers
 16" O/C Roof Studs
 Smooth Aluminum Wheel Boxes
 Spread Axle Design w Individual Fenderettes
 Grey Mod Wheels w/ Radial Tires - Nitro Fill
 Winch Plate
 Spare Tire Wall Mount Backer

Exterior

.030 Aluminum Skin - Screwless
 One-Piece Aluminum Roof
 3" Upper Rub Rail Trim
 3" Lower Rub Rail Trim
 LED Clearance Lights
 LED Tail Lights
 24" ATP Stoneguard
 36" 110 Series Door w/ Slam Latch
 Cast Corners w SS Vertical And Horizontal
 Rear Ramp Door w Spring Assist - Engineered Floor
 Transition Flap - Engineered Floor
 Aluminum Bar Locks - Rear Ramp Door
 Rear Skid Plates

Interior

3/4" Engineered Subfloor
 (2) 12v LED Dome Lights w Switch
 (1) Roof Vent w Maxxair Cover
 7.0' Interior Height
 (4) 5000# Recessed D-Rings
 4' Beavertail -(3' for 20' trailer)
 3/8" Engineered Wood Walls
 Open Stud Ceiling w Mill Finish Cove

Flow-Through Vents
 Upgrade to Aluminum Wheels
 Spare Tire on Steel w Wall Mount
 Spare Tire on Alum w Wall Mount

PACKAGES

Exterior Package

- Perimeter Skirting With Reverse Beavertail
- 4" Trim - Upper and Lower
- Rear Spoiler - Mill Finish w/ 3 LED Lights
- Aluminum Wheels with Radial Tires

Interior Package

- TPO - Black Coin Floor
- TPO - Black Coin Ramp and Trans Flap
- Screwless Aluminum - Walls and Ceiling - White (Black Cove & SP Box)

Deluxe Package

- Perimeter Skirting with Reverse Beavertail
- 4" Trim - Upper and Lower
- Rear Spoiler - Mill Finish w/ (3) LED Lights
- Radial Tires on Aluminum Wheels
- TPO - Black Coin Floor
- TPO - Black Coin Ramp and Trans Flap
- Screwless Aluminum - Walls and Ceiling - White (Black Cove & SP Box)
- Required Choice of Cabinet Package - See Options Above
- 30 Amp Breaker w/ 60 Amp Converter
- 12V Fuse Panel - INTELI-PWR
- (4) Rectangular - LED Ceiling Lights
- (3) Interior GFI Outlets - (1) Exterior GFI Outlet
- A/C Prep
- Slide In/Out Aluminum Step
- 12V AGM Battery

2021 Specification Sheets

Raven Limited Car Hauler

Box Width	8.5'			
Unit Length	20'	20'	24'	28'
Box Height	94"	94"	94"	94"
Overall Length (add 6" with spoiler)*	24'4"	24'4"	28'4"	32'4"
Overall Width	102"	102"	102"	102"
Overall Height (roof vent)	111 - 1/2"	111 - 1/2"	111 - 1/2"	113 - 1/4"
Interior Length *	19'11"	19'11"	23'11"	27'11"
Interior Width *	97.5"	97.5"	97.5"	97.5"
Interior Height *	84"	84"	84"	84"
Minimum ground clearance ***	9 - 3/16"	9 - 3/16"	9-1/16"	9-1/16"
Deck Height **	20 - 3/16"	20 - 3/16"	20 - 1/16"	22"
Rear Door Opening Width	89 - 7/8"	89 - 7/8"	89 - 7/8"	89 - 7/8"
Rear Door Opening Height	82 - 7/8"	82 - 7/8"	82 - 7/8"	82 - 7/8"
Tongue Length to Center of Ball	48"	48"	48"	48"
Center of Coupler to Corner Radius	70 - 1/2"	70 - 1/2"	70 - 1/2"	70 - 1/2"
Width Between Wheel Wells	83"	83"	83"	83"
Axle Type	Torsion	Torsion	Torsion	Torsion
Axle Rating	3500	5200	5200	5200
Axle Quantity	2	2	2	2
GVWR	7700	9990	9990	9990
Brakes	4 Wheel Electric	4 Wheel Electric	4 Wheel Electric	4 Wheel Electric
Tire Size	205/75R15LRD	225/75R15LRE	225/75R15LRE	225/75R15LRE
Hitch Height to Top of Ball	19 - 3/16"	19 - 1/16"	19'	21"
Hitch Ball Size	2-5/16"	2-5/16"	2-5/16"	2-5/16"
Floor Crossmembers	16"	16"	16"	16"
Wall Studs	16"	16"	16"	16"
Ceiling Crossmembers	16"	16"	16"	16"

Notes

*Al Interior, No Cabinets

** Torsion loads not configured

*** Deluxe PKG with Step

All dimensions Nominal

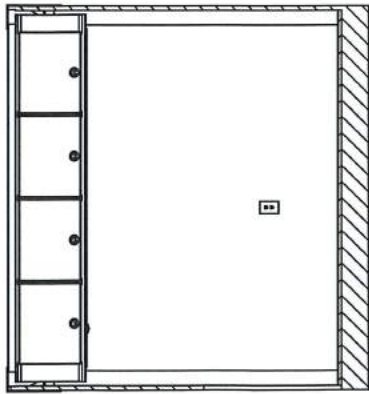

CABINET OPT. 1
UPPER ONLY

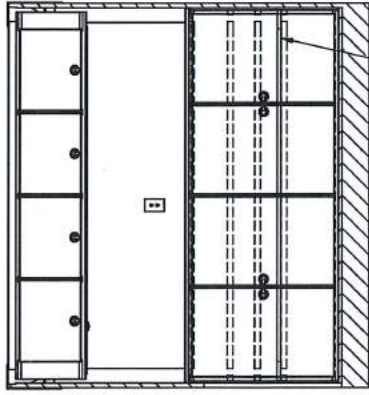

CABINET OPT. 2
STRAIGHT LOWER, UPPER

ADJUSTABLE SHELVES,
LEFT & RIGHT WITH (3) HEIGHT
POSITIONS; BOTH SHOWN IN
BOTTOM POSITION.

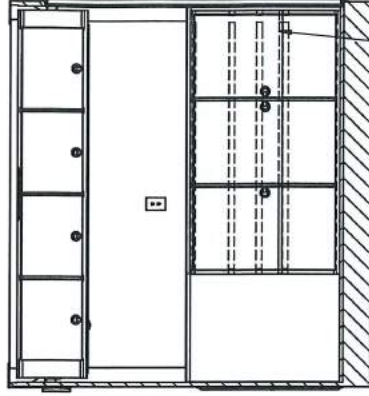

CABINET OPT. 3
L BASE LOWER, UPPER
36" X 36" GEN. DOOR, UPPER

ADJUSTABLE SHELVES,
LEFT & RIGHT WITH (3) HEIGHT
POSITIONS; BOTH SHOWN IN
BOTTOM POSITION.



NOTE:
ALL UPPER CABINETS HAVE LED STRIP LIGHT AND
SWITCH AS STANDARD.

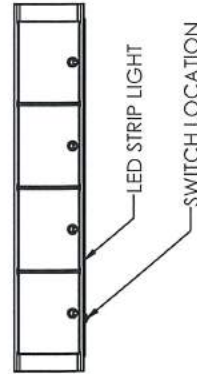

LED STRIP LIGHT
SWITCH LOCATION

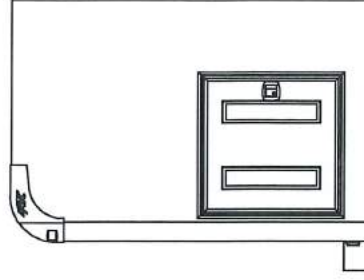
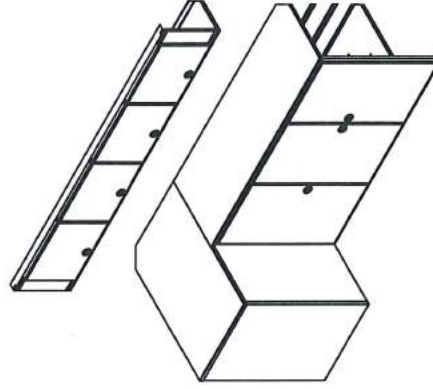
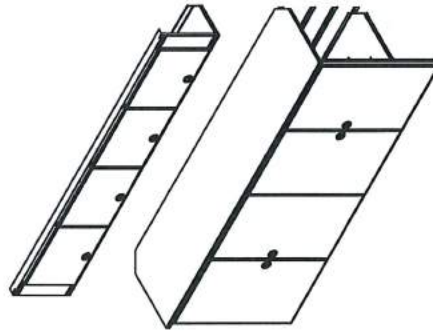

CABINET OPT. 3
EXTERIOR VIEW

DIMENSION TOLERANCES	PART #	VIN	TITLE:
STANDARD			RCL - CH LIMITED - CABINET OPTIONS 1-3
+			MATERIAL: (THICKNESS - TYPE - GRADE)
-			REVISION: QUANTITY: WEIGHT:
CRITICAL			LBS
+			
-			



PROPRIETARY AND CONFIDENTIAL: THE
INFORMATION CONTAINED IN THIS DRAWING IS
THE SOLE PROPERTY OF THE ALUMINUM TRAILER
COMPANY. ANY REPRODUCTION IN PART OR AS
A WHOLE WITHOUT THE WRITTEN PERMISSION OF
THE ALUMINUM TRAILER COMPANY IS PROHIBITED.

DRAWN BY:
CF
DATE:
4/8/2021
SCALE: 1:24
SHEET 1 OF 1

CONFIGURATIONS DISPLAYED:
 20 FT RAVEN LIMITED CAR HAULER
 DELUXE PACKAGE
 CABINET PACKAGE 1
 3500# AXLES

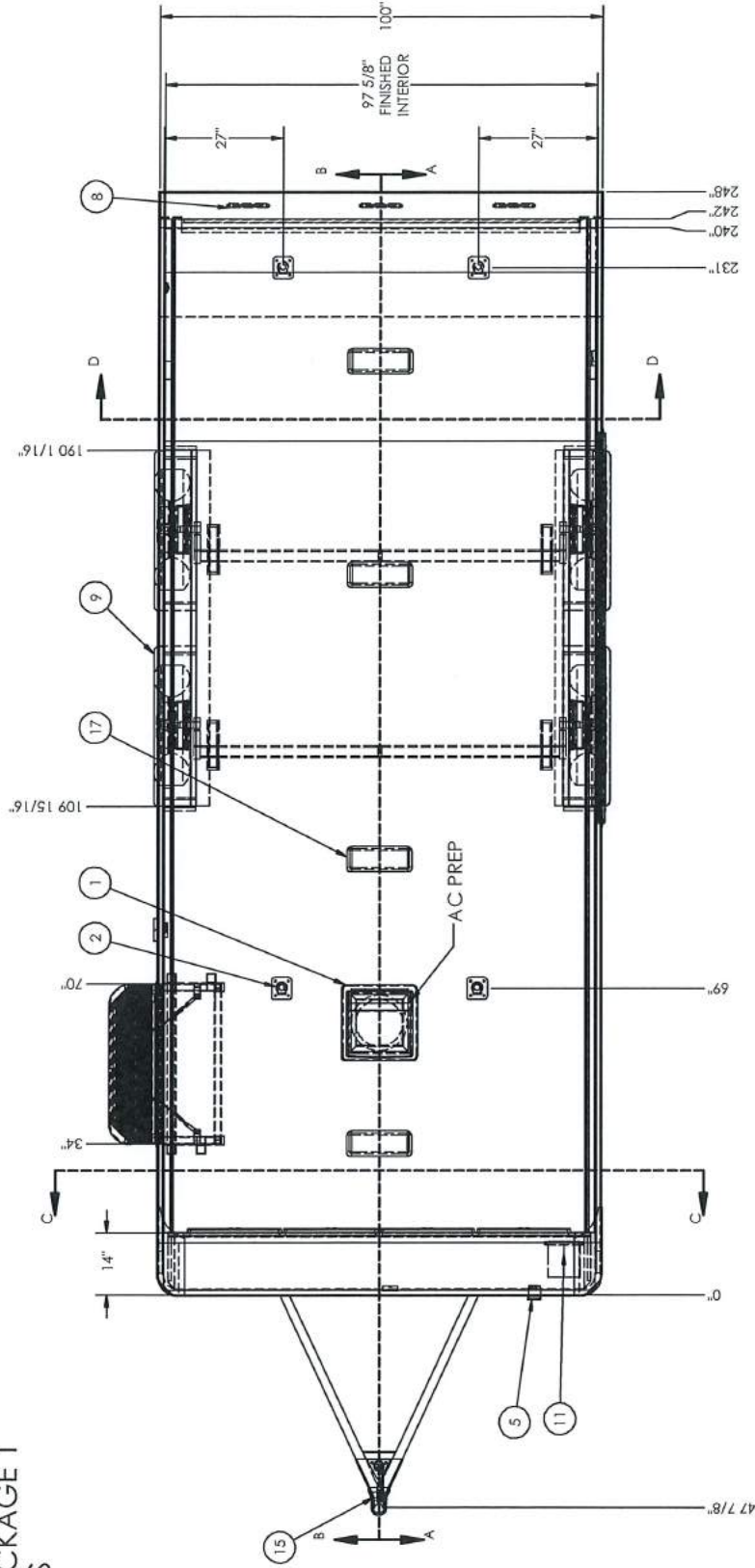

ITEM NO	PART NO	FILE NAME	DESCRIPTION	QTY.
1	124898	VENT - ROOF - MANUAL - 14" - W/MAXXAIR COVER		1
2	137102	D-RINGS - 5000# - RECESSED		4
3	130412	SWITCH - WALL - 12V - BLACK		2
4	131276	7 - Way Truck Plug		1
5	133279	POWER INLET - MOTORBASE - 30A - W/ SHORE CORD - 25'		1
6	137105	RECEPT - EXTERIOR - 120V - 15A - GFI PROTECTED		1
7	137107	RECEPT - INTERIOR - 120V - 15A		3
8	87493	BACK UP LIGHT		3
9	41700	Aluminum Fender	Mill Finish - 84" Ext. Length	2
10		ASSEMBLY - CABINET PACKAGE - CH - 920		1
11		BREAKER BOX	30 AMP WITH CONVERTER	1
12		CAST CORNERS		1
13		DOOR - ENTRY - 110 SERIES - 36 X 78 - RH - FI - 20 ft Marketing		1
14		DOOR - ESCAPE - PREMIUM - 88W X 66H X 11WW X 10FRM - 224661		1
15		FRM, AL - Car Hauler 2021 - Raven - 20 ft Marketing		1
16		Ground - 20 ft Raven		1
17		LIGHT - CEILING - SURFACE MOUNT		4
18		RCL Cullists - 20 ft Marketing		1
19		TRANSITION FLAP - 20 ft Raven Marketing		1
20	41396	WHEEL WELL, AL - QUEST		1
21		WHEEL WELL, AL - QUEST	7.5 x 11 x 80 FED	1

ALL LOCATIONS ARE NOMINAL UNLESS CRITICAL DIMENSIONS ARE SPECIFICALLY NOTED

REV. _____ DATE _____

DESCRIPTION _____

REVISION TABLE

DATE _____

DONE BY _____

REV. _____

DRAWN BY: _____ DATE: 05/05/21

HRM _____ VIN/PART # _____

FILE NAME: CUS, AL - Car Hauler 2021 - Raven - 20 ft Marketing

SCALE: 1:20 DATE PRINTED: 5/25/2021 SHEET 1 OF 6

MARKETING

WORLD CLASS TRAILERS

ATC

TITLE: 20 FT RCL - RAVEN LIMITED CH

PROPRIETARY AND CONFIDENTIAL: THIS DRAWING IS THE SOLE PROPERTY OF THE ALUMINUM TRAILER MANUFACTURER. REPRODUCTION IN PART OR AS A WHOLE WITHOUT THE WRITTEN PERMISSION OF THE ALUMINUM TRAILER COMPANY IS PROHIBITED.

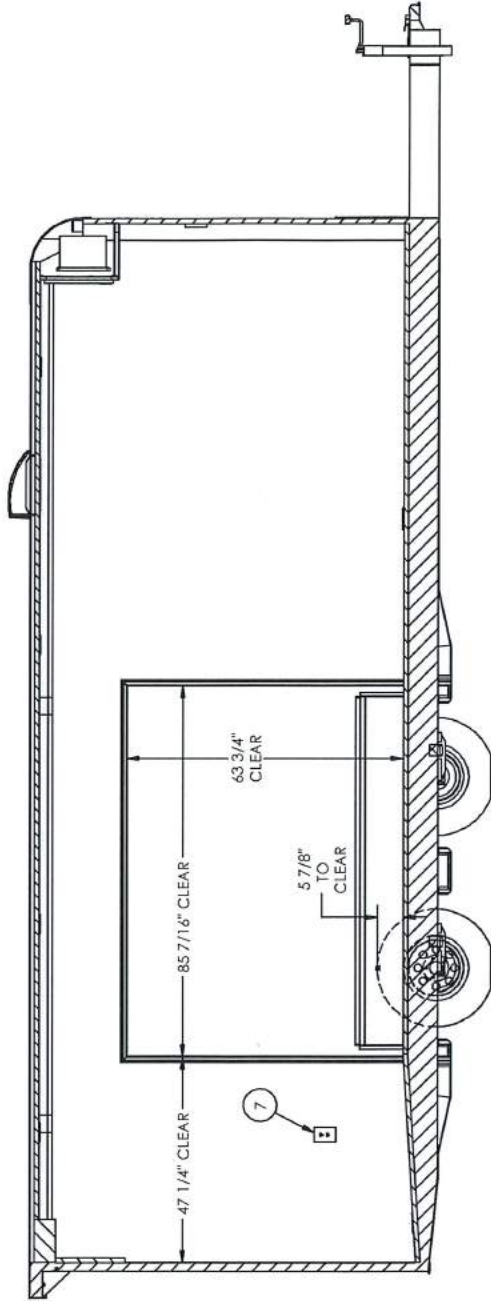

INTERIOR ROADSIDE

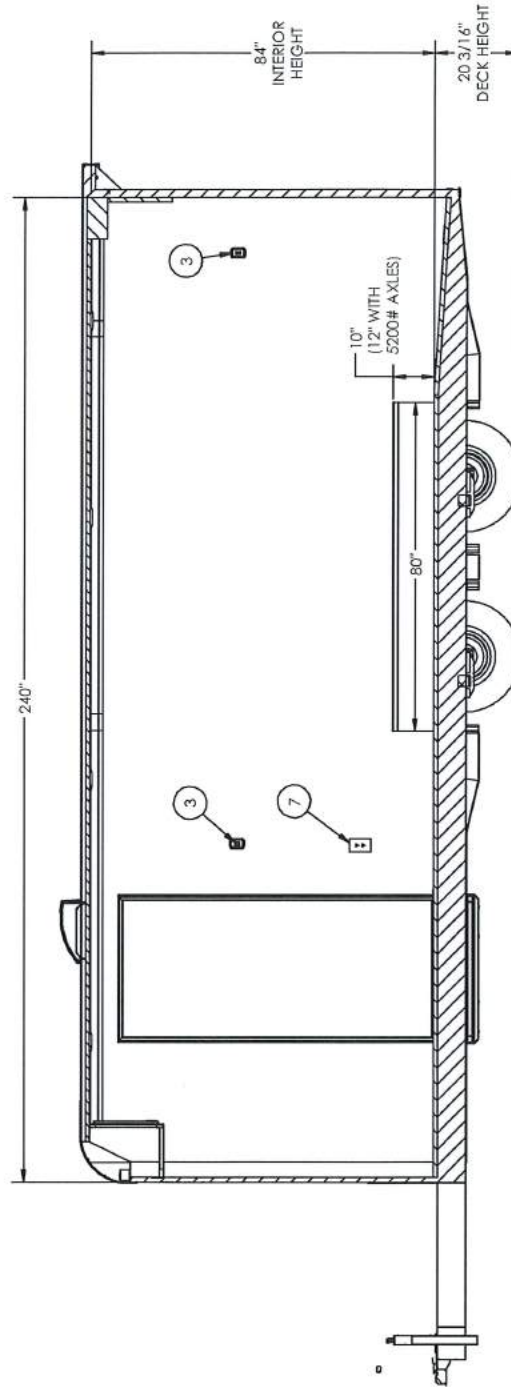

INTERIOR CURBSIDE



TITLE: 20 FT RCL - RAVEN LIMITED CH	
DRAWN BY: HRM	VIN/PART # 05/05/21 MARKETING
DATE: 05/05/21	REV.:
FILE NAME: CJS, AL - Car Hauler 2021 - Raven - 20 ft Marketing	
SCALE: 1:64	DATE PRINTED: 5/25/2021
	SHEET 2 OF 6

CABINET PACKAGE 1 SHOWN.
REFER TO CABINET PRINTS FOR
OTHER CABINET OPTIONS.

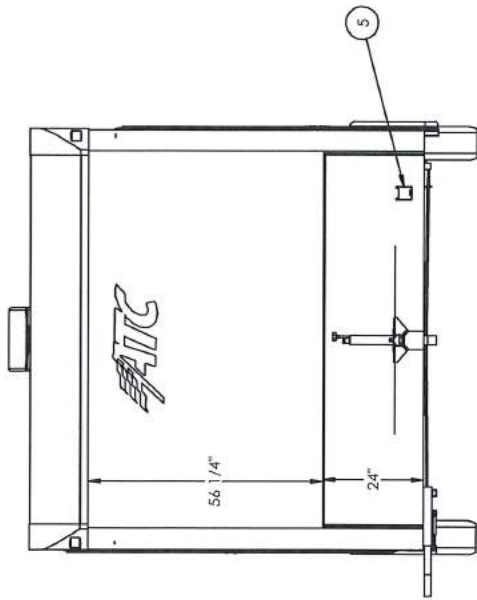

EXTERIOR FRONT

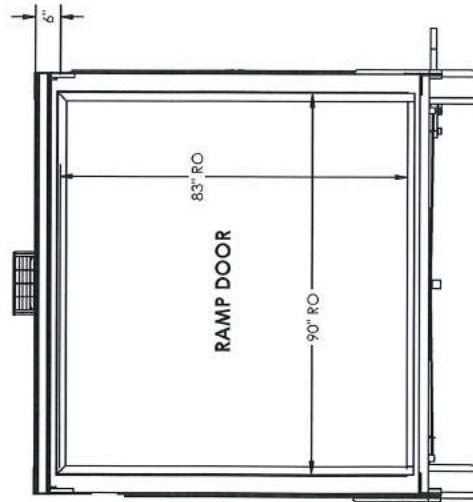

EXTERIOR REAR

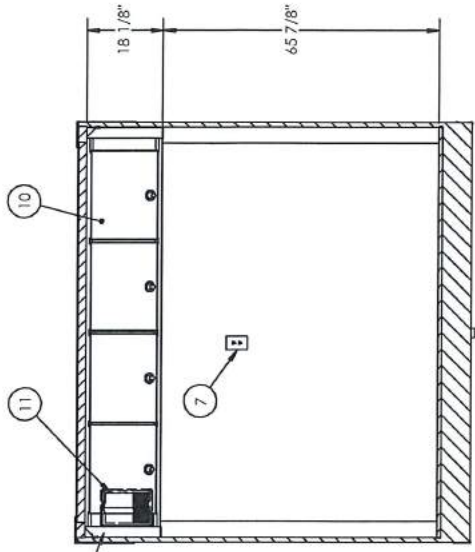

INTERIOR FRONT

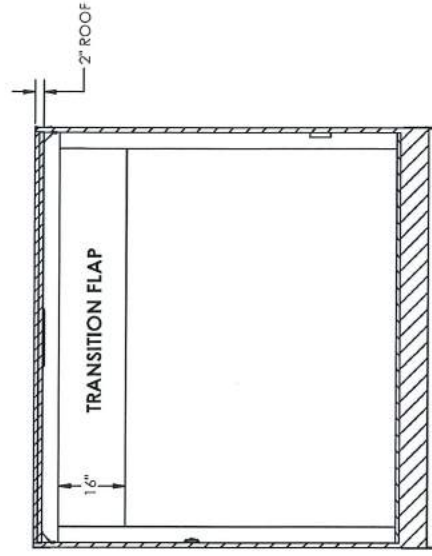

INTERIOR REAR



TITLE: 20 FT RCL - RAVEN LIMITED CH	
DRAWN BY: HRM	DATE: 05/05/21
FILE NAME: CUS_AI - Car Hauler 2021 - Raven - 20 ft Marketing	REV. MARKETING
SCALE: 1:64	DATE PRINTED: 5/25/2021
	SHEET 3 OF 6

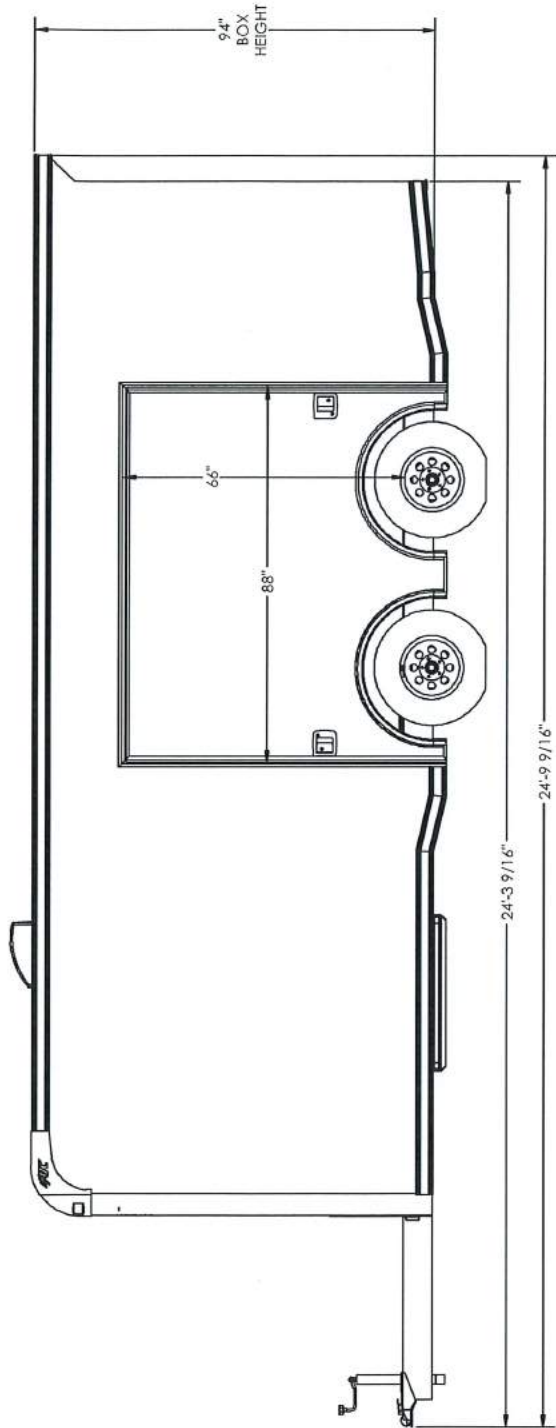

EXTERIOR ROAD SIDE

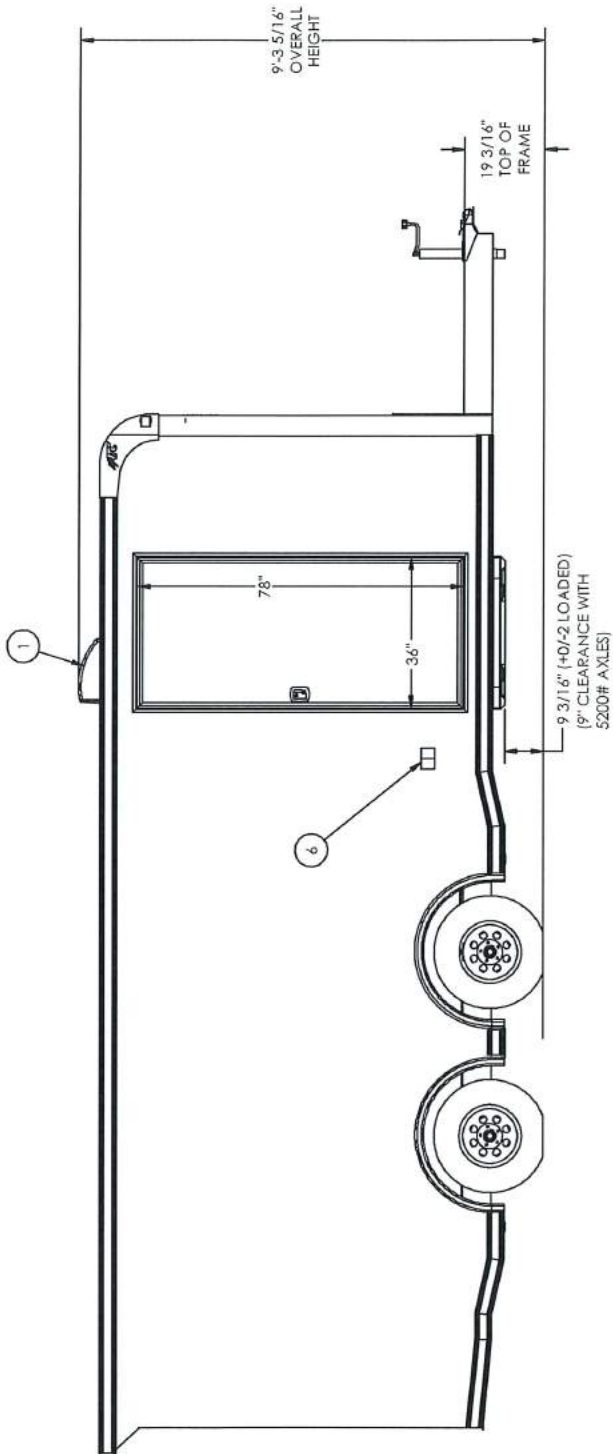

EXTERIOR CURB SIDE



TITLE: 20 FT RCL - RAVEN LIMITED CH

DRAWN BY: DATE: VIN/PART # REV.

HRM 05/05/21 MARKETING

FILE NAME: CJS, AL - Car Hauler 2021 - Raven - 20 ft Marketing

SCALE: 1:64 DATE PRINTED: 5/25/2021 SHEET 4 OF 6



ROAD SIDE VIEW

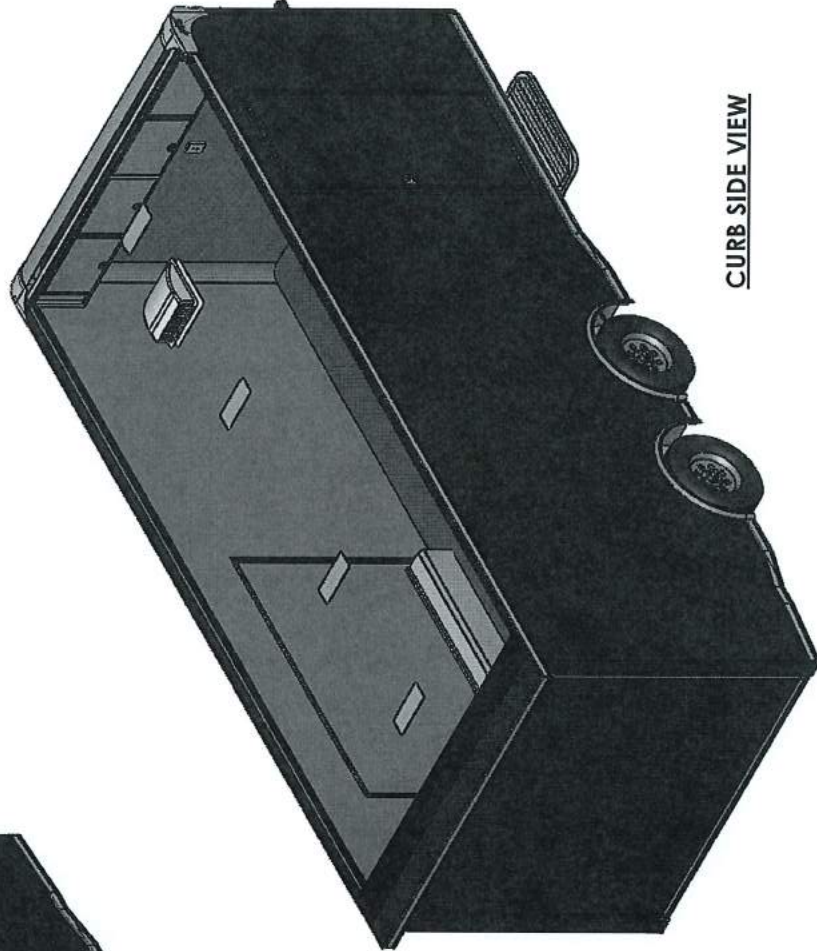

CURB SIDE VIEW



TITLE:	20 FT RCL - RAVEN LIMITED CH		
DRAWN BY:	DATE:	VIN/PART #	REV.
HRM	05/05/21	MARKETING	
FILE NAME: CUS_AL - Car Hauler 2021 - Raven - 20 ft Marketing			
SCALE: 1/24 DATE PRINTED: 5/25/2021 SHEET 5 OF 6			

20'-8 5/16"
OVERALL
BOX LENGTH

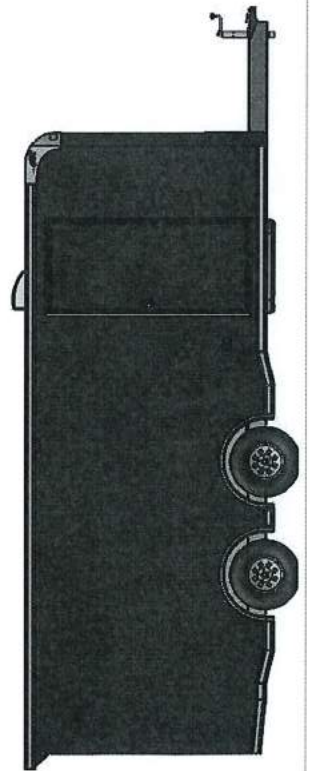
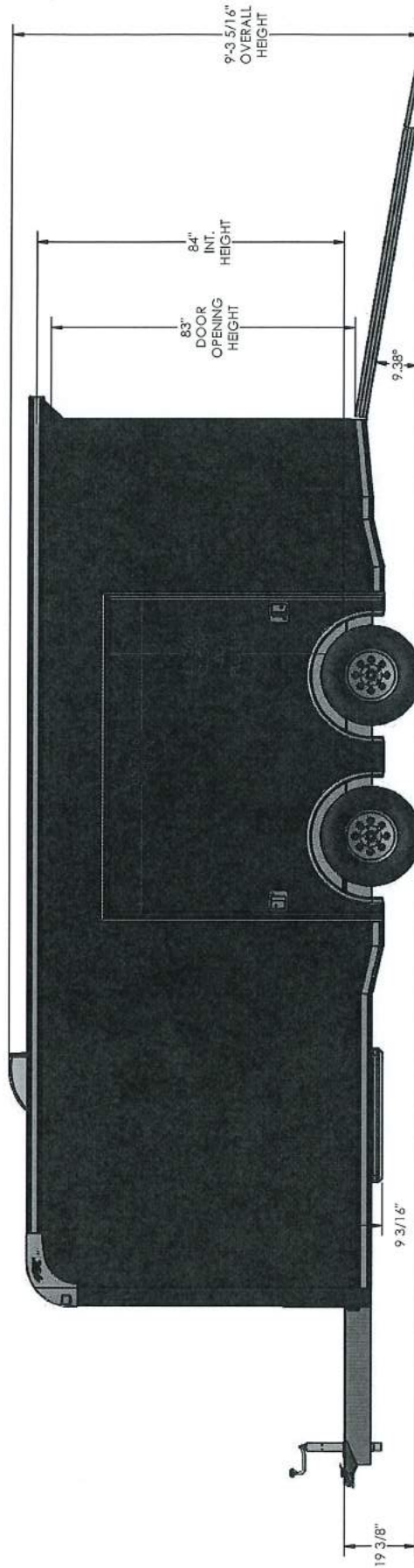
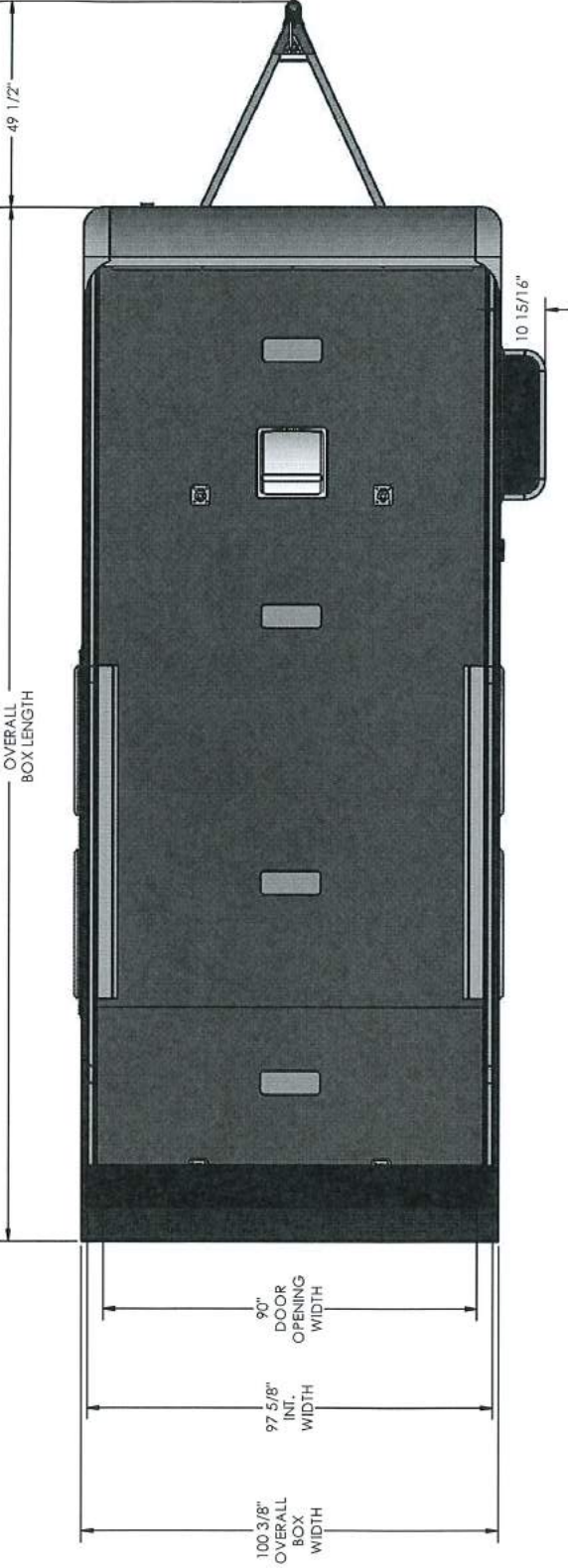

TITLE: 20 FT RCL - RAVEN LIMITED CH	
DRAWN BY: HRM	DATE: 05/05/21
REV.:	VN/PART # MARKETING
FILE NAME: CUS, AL - Car Hauler 2021 - Raven - 20 ft Marketing	
SCALE: 1:22	DATE PRINTED: 5/25/2021
SHEET 6 OF 6	

CONFIGURATIONS DISPLAYED:
 24 FT RAVEN LIMITED CAR HAULER
 DELUXE PACKAGE
 CABINET PACKAGE 2
 5200# AXLES
 FLOW THROUGH VENTS
 SPARE TIRE MOUNT

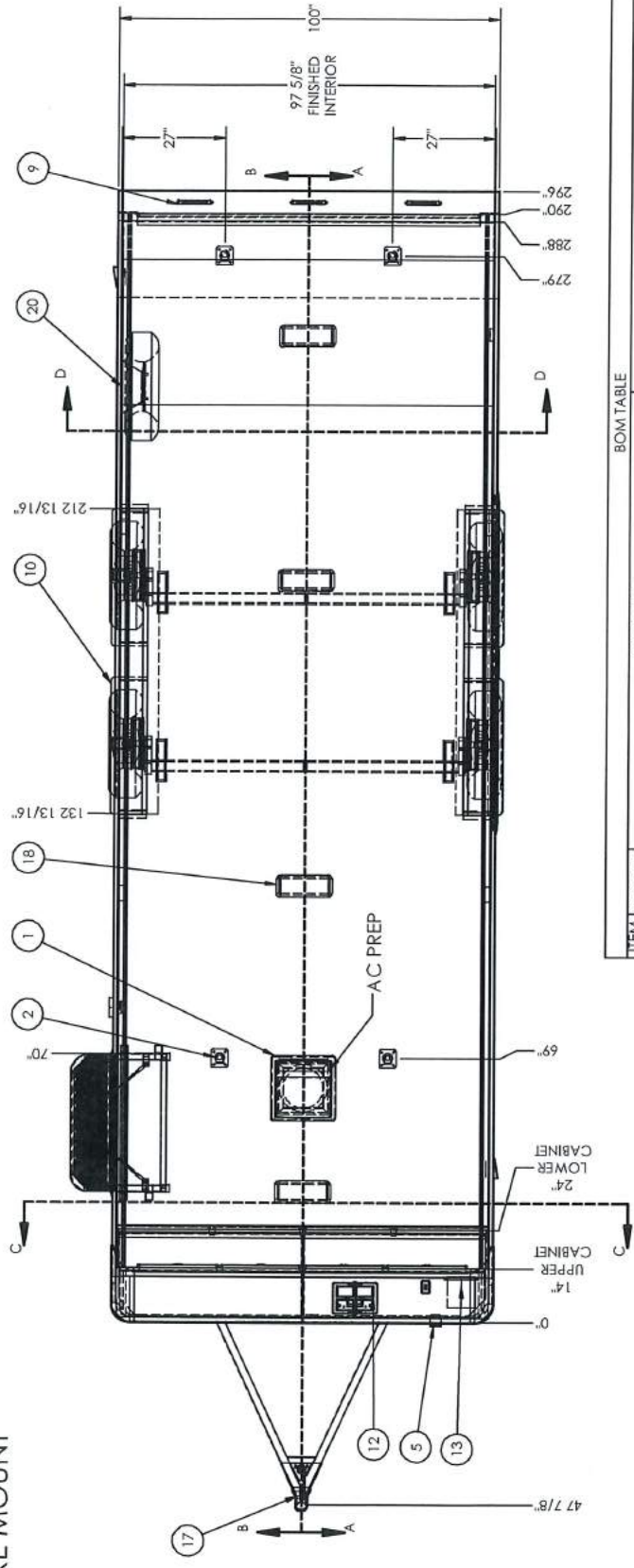

ITEM NO.	PART NO.	FILE NAME	DESCRIPTION	QTY.
1	124898		VENT - ROOF - MANUAL - 14" - W/ MAX AIR COVER	1
2	137102	125777	D-RINGS - 5000# - RECESSED	4
3	130412	130412	SWITCH - WALL - 12V - BLACK	3
4	131276	131276	7 - W/ V Truck plug	1
5	133279	133279	POWER INLET - MOTORBASE - 30A - W/ SHORE CORD - 75'	1
6	134945	134945	VENT SYSTEM - FLOW THROUGH - BLACK - 16" O/C	2
7	137105	137105	RECEPT - EXTERIOR - 120V - 15A - GF PROTECTED	2
8	137107	137107	RECEPT - INTERIOR - 120V - 15A	3
9	87493		BACK UP LIGHT	3
10	41700	Aluminum Fender	Mill Finish - 84" Ext. Length	2
11		ASSEMBLY - CABINET PACKAGE - CH - 920		2
12		BATTERY	AGM, 775 CCA	1
13		BREAKER BOX	30 AMP WITH CONVERTER	1
14		CAST CORNERS		1
15		DOOR - ENTRY - 110 SERIES - 36 X 78 - 24 ft Marketing		1
16		ESCAPE DOOR - AWNING STYLE 88X66X13X10 - 24 ft Marketing		1
17		HRM, AL - Car Hauler 2021 - Raven - 24 ft Marketing		1
18		LIGHT, CEILING - SURFACE MOUNT		1
19		LIGHT, STRIP		4
20		MOUNT, SPARE TIRE - WALL		1
21		RCL, Cufflets - 24 ft Marketing		1
22	40249	WHEEL WELL, AL - GUEST	7.5 x 13 x 80	1
23	117837	WHEEL WELL, AL - GUEST	7.5 x 13 x 80 PED	1
24		DOOR, STAGE - 20 ft Raven Marketing		1
25		TRANSITION FLAP - 20 ft Raven Marketing		1

**ALL LOCATIONS ARE NOMINAL UNLESS CRITICAL
 DIMENSIONS ARE SPECIFICALLY NOTED**

PROPRIETARY AND CONFIDENTIAL:
 THE INFORMATION CONTAINED IN THIS DRAWING IS THE SOLE
 PROPERTY OF THE ALUMINUM TRAILER COMPANY. ANY
 REPRODUCTION IN PART OR AS A WHOLE WITHOUT THE WRITTEN
 PERMISSION OF THE ALUMINUM TRAILER COMPANY IS PROHIBITED.

ATC
 WORLD CLASS TRAILERS

TITLE: 24 FT RCL - RAVEN LIMITED CH
 DRAWN BY: DATE: VIN/PART #
 HRM 05/06/21 MARKETING
 FILE NAME: CUS, AL - Car Hauler 2021 - Raven - 24 ft Marketing
 SCALE: 1:64 DATE PRINTED: 5/24/2021 SHEET 1 OF 6

REV.	DESCRIPTION	DATE	DONE BY

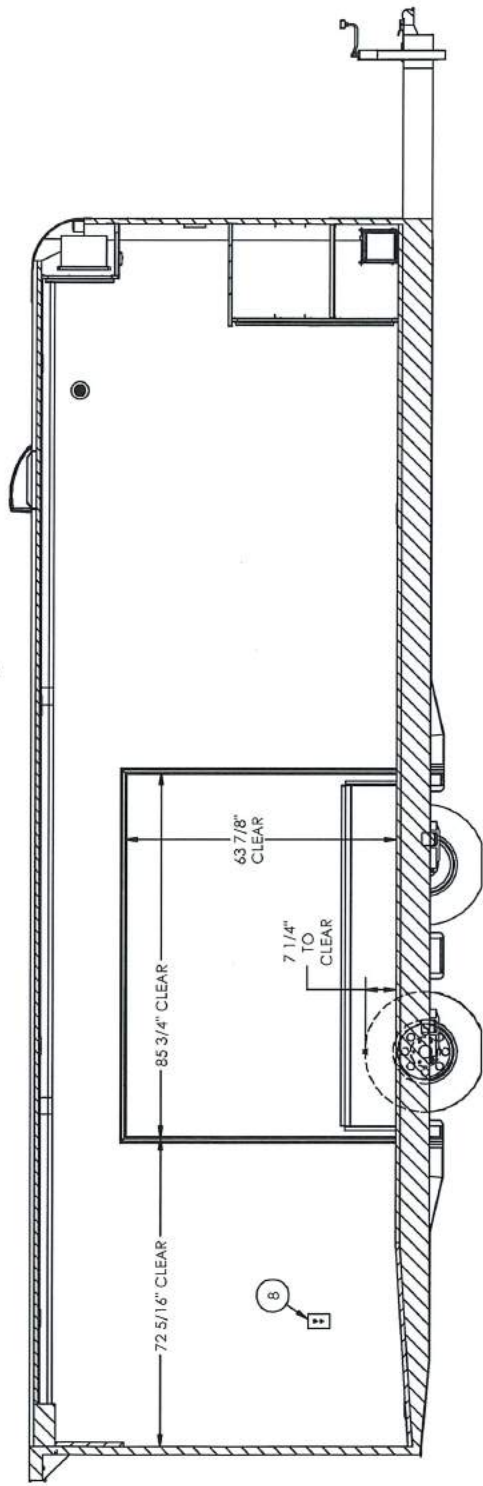

INTERIOR ROADSIDE

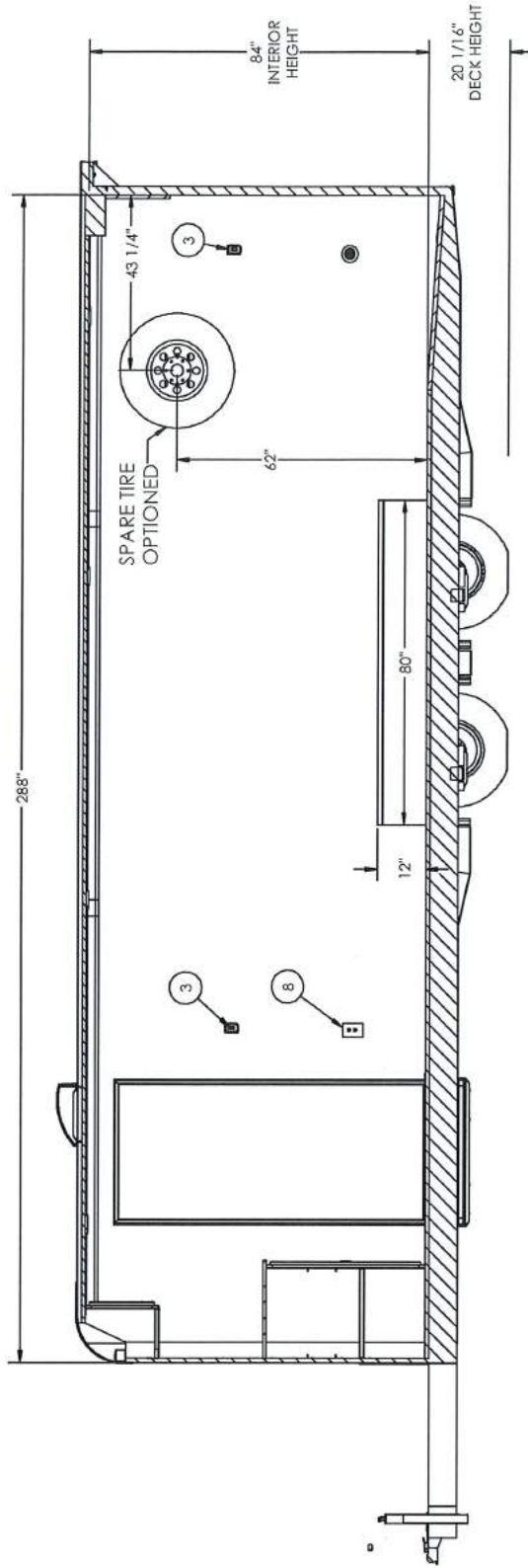

INTERIOR CURBSIDE



TITLE:	24 FT RCL - RAVEN LIMITED CH		
DRAWN BY:	DATE:	VIN/PART #	REV.
HRM	05/06/21	MARKETING	
FILE NAME:	CJS, AL - Car Hauler 2021 - Raven - 24 ft Marketing		
SCALE:	1:64	DATE PRINTED:	5/24/2021
			SHEET 2 OF 6

CABINET PACKAGE 2 SHOWN.
REFER TO CABINET PRINTS FOR
OTHER CABINET OPTIONS.

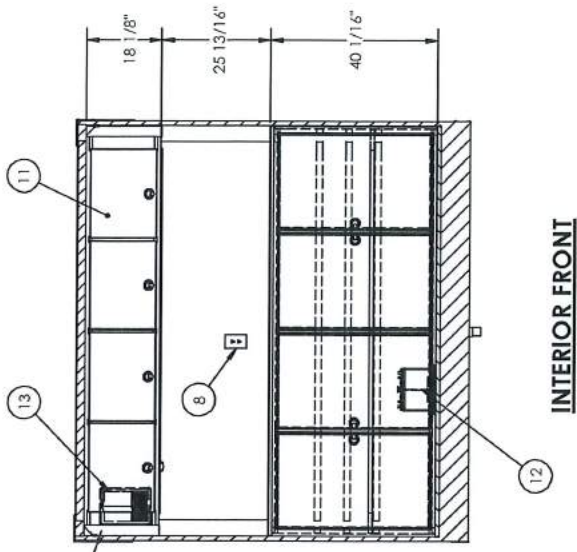

INTERIOR FRONT

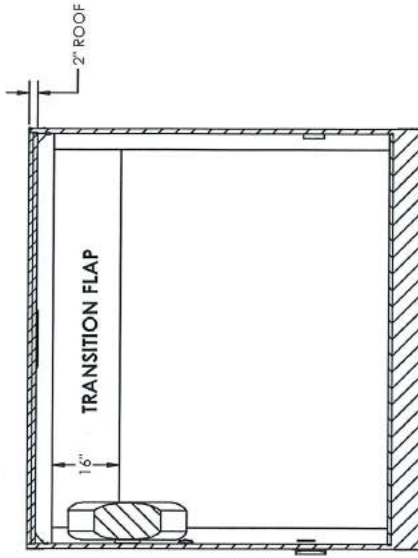

INTERIOR REAR

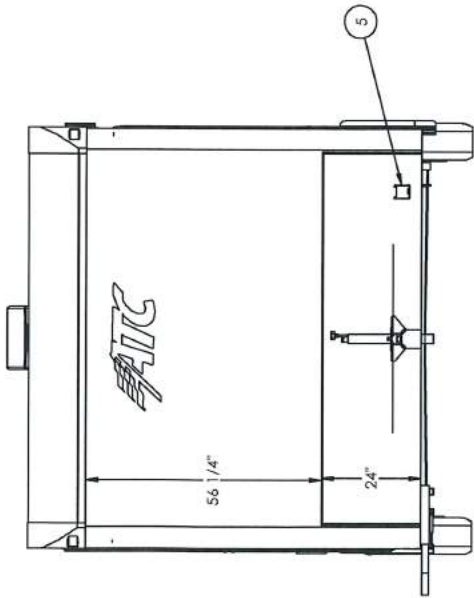

EXTERIOR FRONT

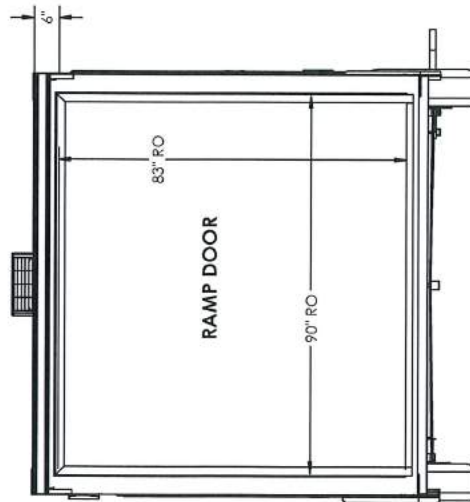

EXTERIOR REAR



TITLE:	24 FT RCL - RAVEN LIMITED CH		
DRAWN BY:	DATE:	VIN/PART #	REV.
HRM	05/06/21	MARKETING	
FILE NAME:	CUS. AL - Car Hauler, 2021 - Raven - 24 ft Marketing		
SCALE:	1:64	DATE PRINTED:	5/24/2021
			SHEET 3 OF 6

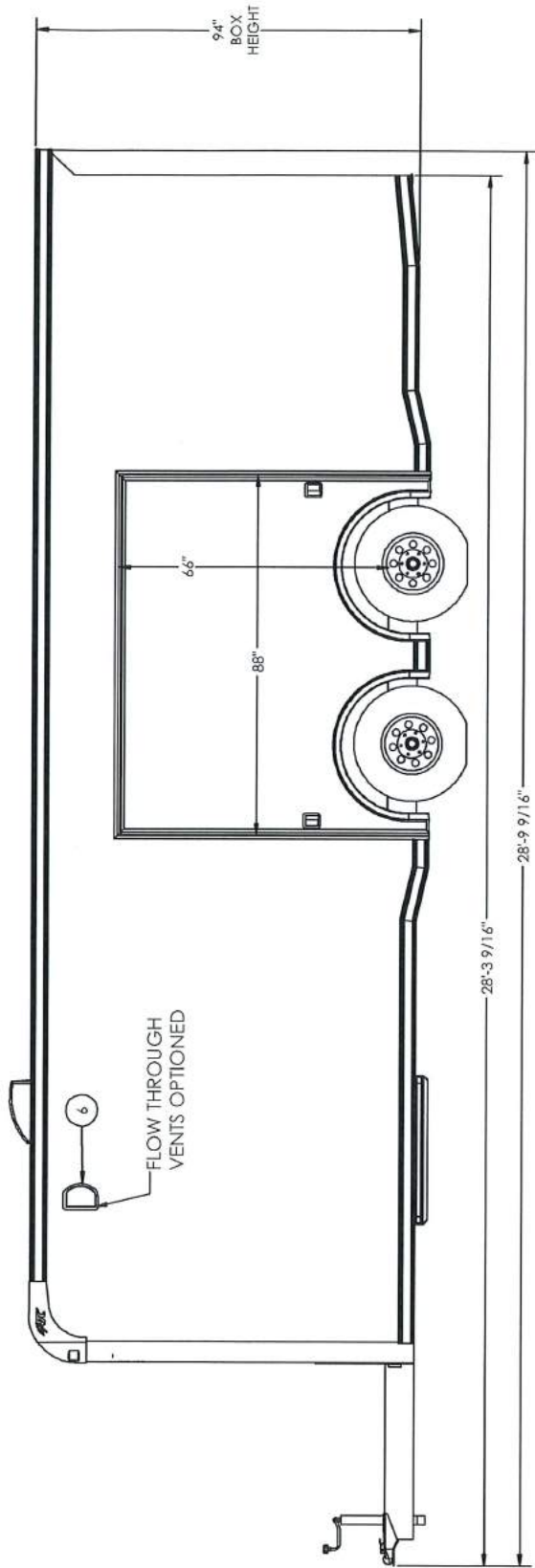

EXTERIOR ROAD SIDE

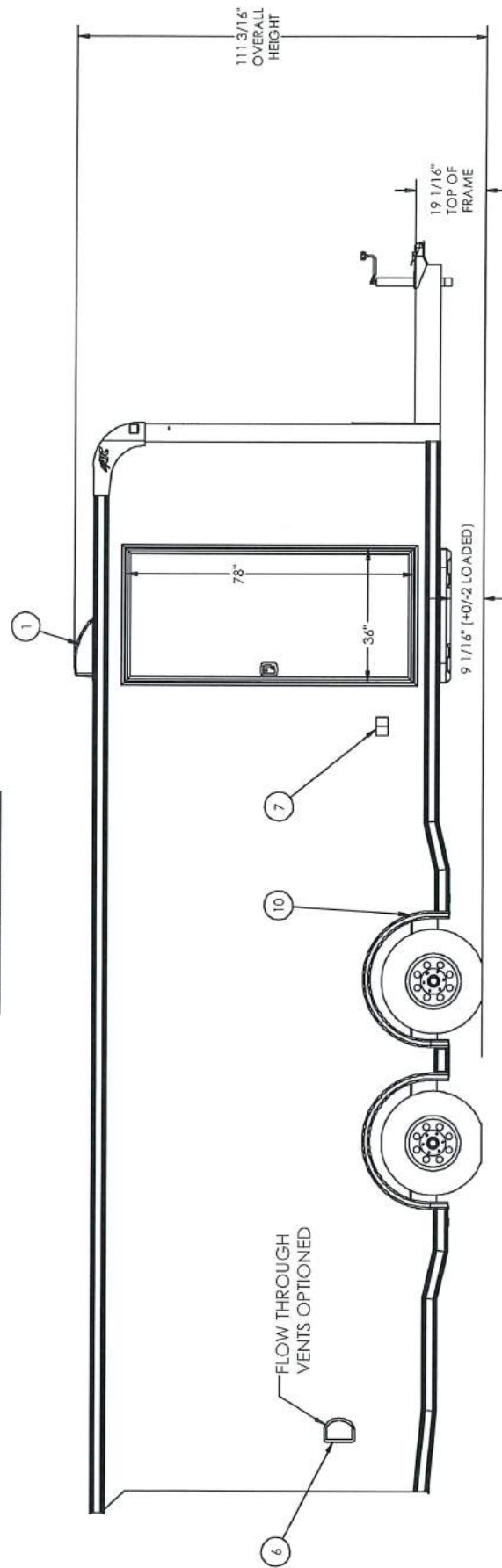

EXTERIOR CURB SIDE



TITLE: 24 FT RCL - RAVEN LIMITED CH			
DRAWN BY: HRM	DATE: 05/06/21	VIN/PART #	REV.
FILE NAME: CUS_AL - Car Hauler 2021 - Raven - 24 ft Marketing	MARKETING		
SCALE: 1:64	DATE PRINTED: 5/24/2021	SHEET 4 OF 6	

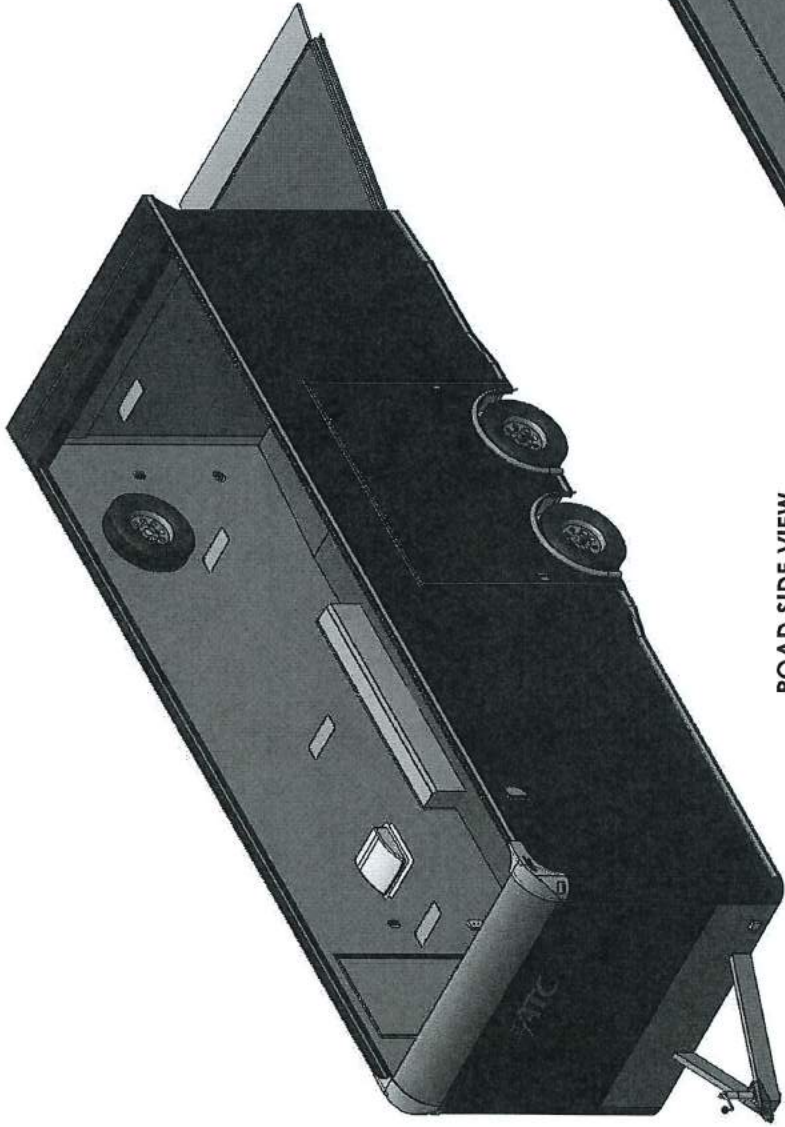

ROAD SIDE VIEW

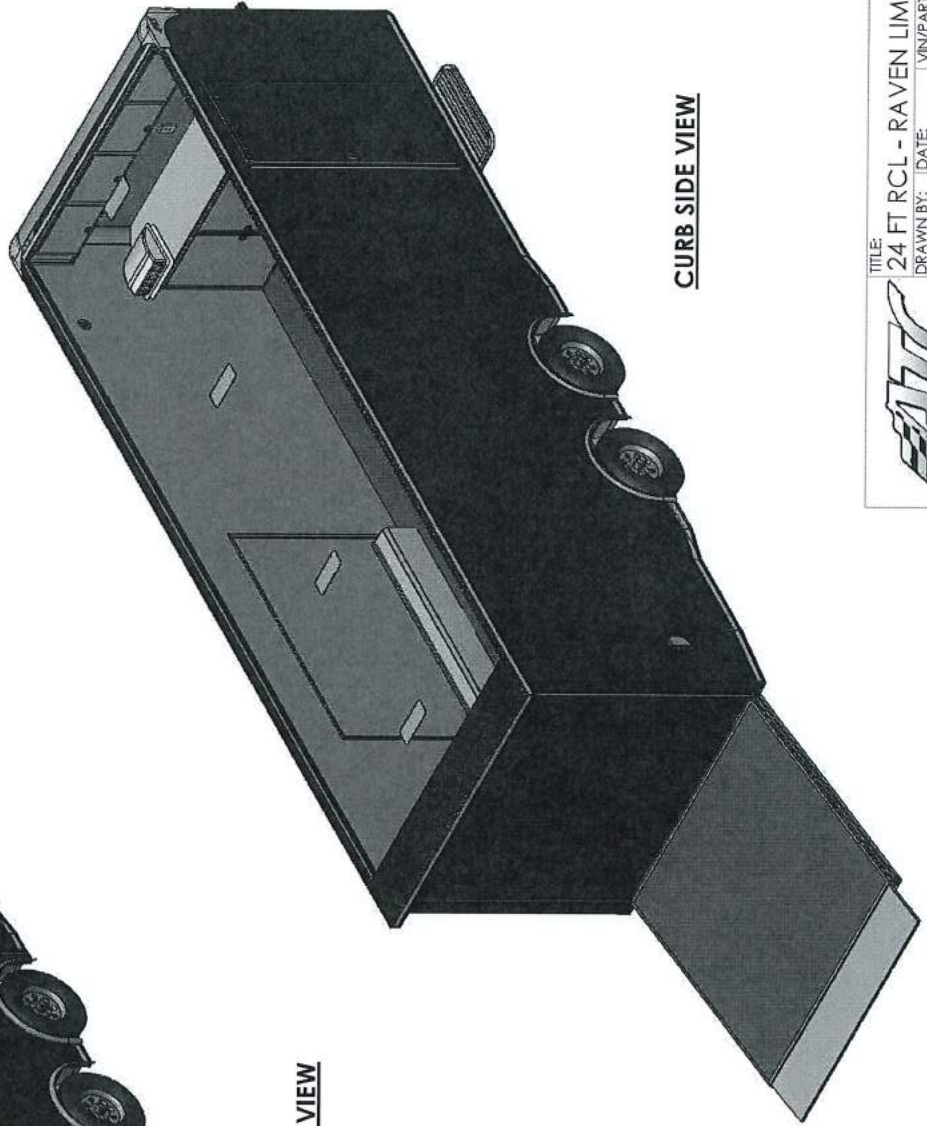

CURB SIDE VIEW



TITLE:	24 FT RCL - RAVEN LIMITED CH		
DRAWN BY:	DATE:	VIN/PART #	REV.
HRM	05/06/21	MARKETING	
FILE NAME: CUS_AL - Car Hauler 2021 - Raven - 24 ft Marketing			
SCALE: 1:28 DATE PRINTED: 5/24/2021 SHEET 5 OF 6			

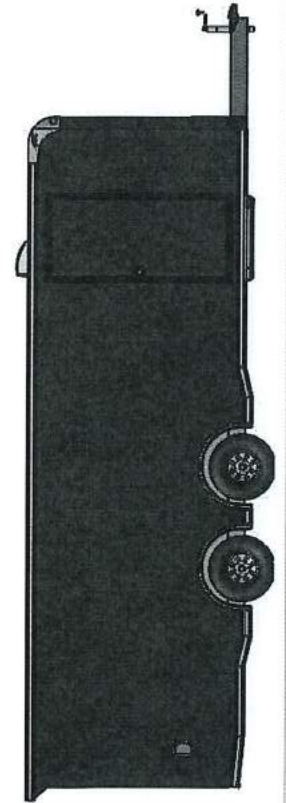
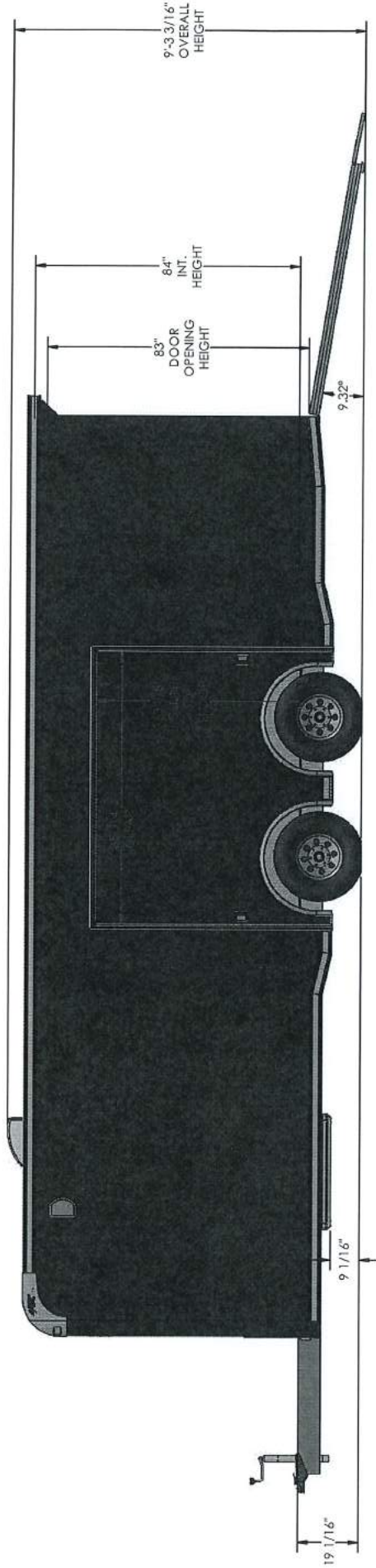
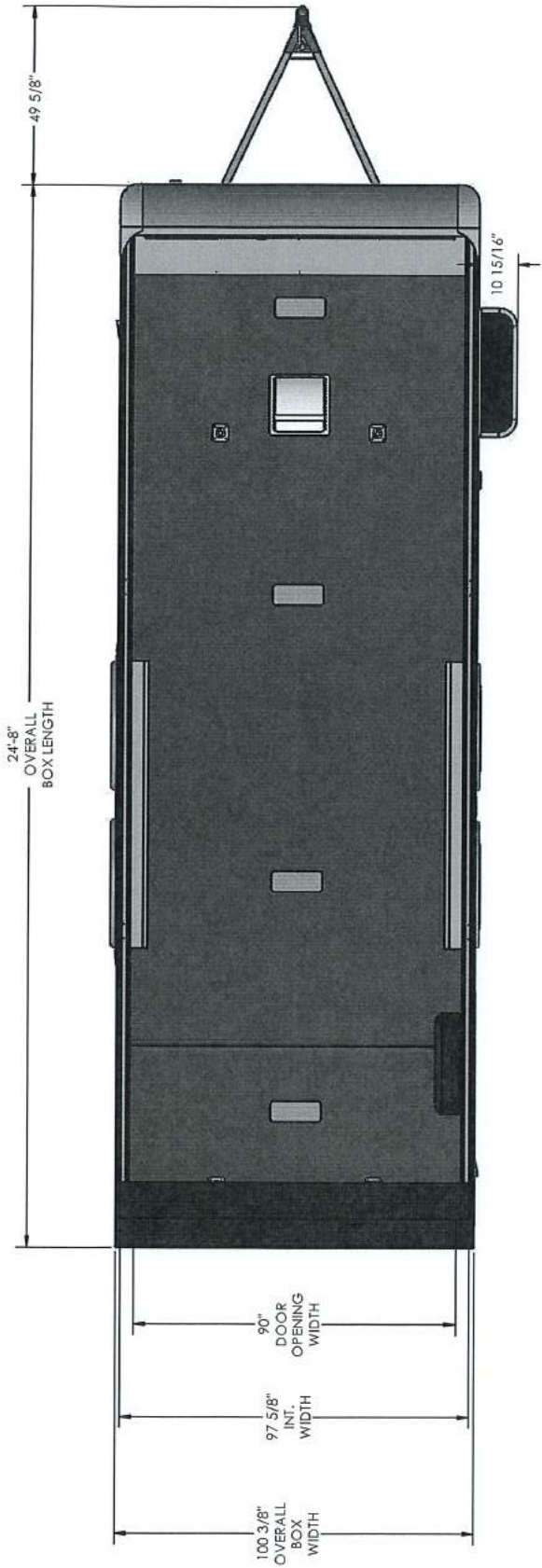

TITLE: 24 FT RCL - RAVEN LIMITED CH		REV.
DRAWN BY: HRM	DATE: 05/06/21	VIN/PART # MARKETING
FILE NAME: CUS, AL - Car Hauler, 2021 - Raven - 24 ft Marketing		SCALE: 1:24
DATE PRINTED: 5/24/2021		SHEET 6 OF 6

CONFIGURATIONS DISPLAYED:
 28 FT RAVEN LIMITED CAR HAULER
 DELUXE PACKAGE
 CABINET PACKAGE 3
 5200# AXLES
 FLOW THROUGH VENTS
 SPARE TIRE MOUNT

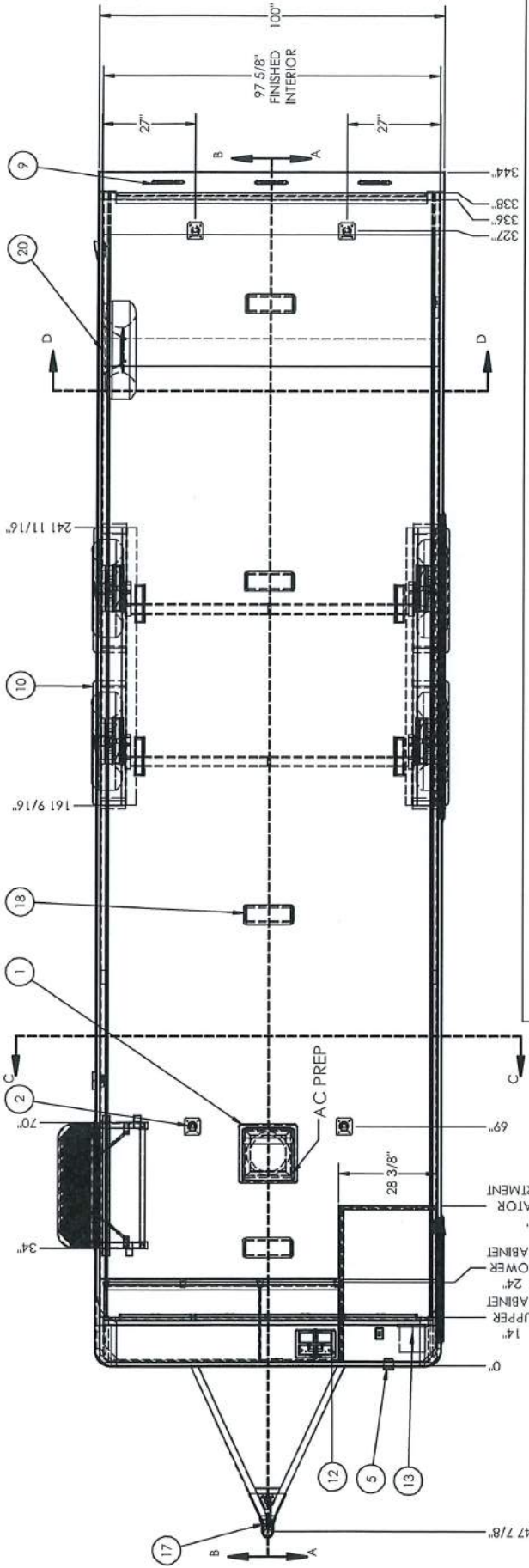

ITEM NO.	PART NO	FILE NAME	DESCRIPTION	QTY.
1	124898	VENT - ROOF - MANUAL - 14" - W/MAXXAIR COVER		1
2	137102	D-RINGS - 5000# - RECESSED		4
3	130412	SWITCH - WALL - 12V - BLACK		3
4	131276	7 - 120V TRUCK PLUG		1
5	133279	POWER INLET - MOTORBASE - 30A - W/ SHORE CORD - 25'		1
6	136945	VENT SYSTEM - FLOW THROUGH - BLACK - 1.6" O/C		2
7	137105	RECEPT - EXTERIOR - 120V - 15A - GFI PROTECTED		1
8	137107	RECEPT - INTERIOR - 120V - 15A		3
9	87493	BACK UP LIGHT		2
10	41700	Aluminum Fender	Mill Finish - 84" Ext. Length	2
11		ASSEMBLY - CABINET PACKAGE - CH - 920 - 28 ft Marketing		1
12		BATTERY	AGM, 77.5 CCA	1
13		BREAKER BOX	30 AMP WITH CONVERTER	1
14		CAST CORNERS		1
15		DOOR - ENTRY - 110 SERIES - 36 X 78 - 8H - FL - 28 ft Marketing		1
16		DOOR - ESCAPE - PREMIUM - 88W X 66H X 11WW X 12FRM - 28 ft Marketing		1
17		FRM, AL - Car Hauler 2021 - Raven - 28 ft Marketing		1
18		LIGHT, CEILING - SURFACE MOUNT		1
19		LIGHT, STRIP		4
20		MOUNT, SPARE TIRE - WALL		1
21		PCL, Cutlits - 28 ft Marketing		1
22	41396	WHEEL WELL, AL - GUEST	7.5 x 11 x 80	1
23		WHEEL WELL, AL - GUEST	7.5 x 11 x 80 PED	1
24		DOOR, STAGE - 20 ft Raven Marketing		1
25		TRANSITION FLAP - 20 ft Raven Marketing		1
26		Ground - 20 ft Raven		1

ATC
 WORLD CLASS TRAILERS

REVISION TABLE

REV.	DESCRIPTION	DATE	DONE BY

MARKETING

DATE: 05/07/21
 HRM:

FILE NAME: C:\Eng_Vault\Master Records\Templates\CAR HAULER_Marketing\28 ft Raven\

SCALE: 1:64 DATE PRINTED: 5/25/2021 SHEET 1 OF 6

TITLE: 28 FT RCL - RAVEN LIMITED CH

ALL LOCATIONS ARE NOMINAL UNLESS CRITICAL DIMENSIONS ARE SPECIFICALLY NOTED

PROPRIETARY AND CONFIDENTIAL:
 THE INFORMATION CONTAINED IN THIS DRAWING IS THE SOLE PROPERTY OF THE ALUMINUM TRAILER COMPANY, INC.
 REPRODUCTION IN PART OR AS A WHOLE WITHOUT THE WRITTEN PERMISSION OF THE ALUMINUM TRAILER COMPANY IS PROHIBITED.

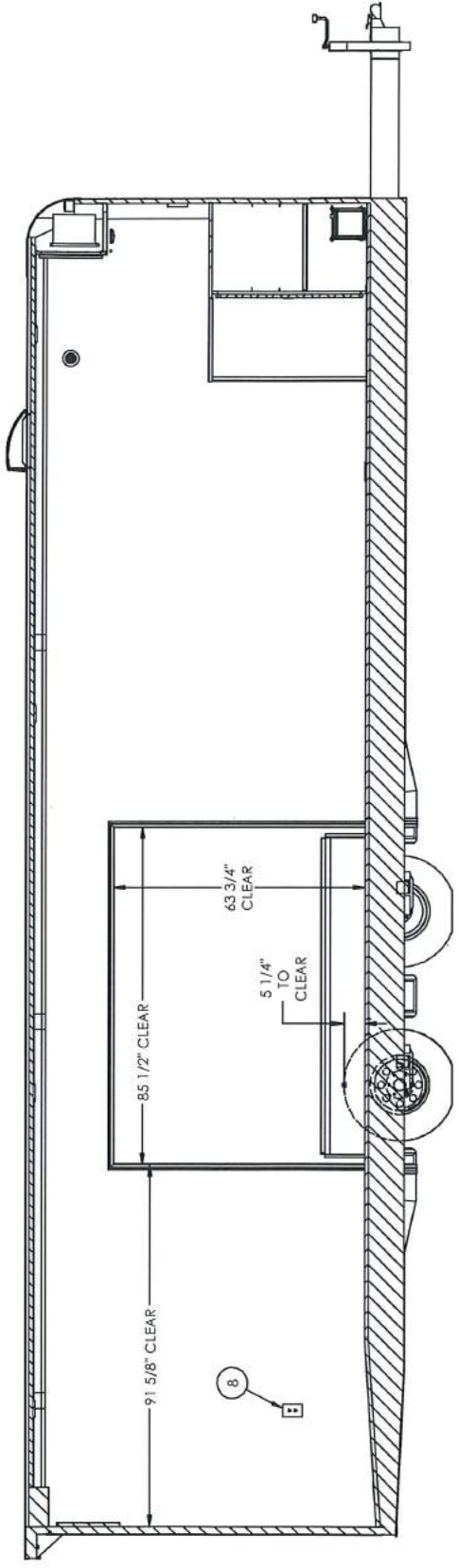

INTERIOR ROADSIDE

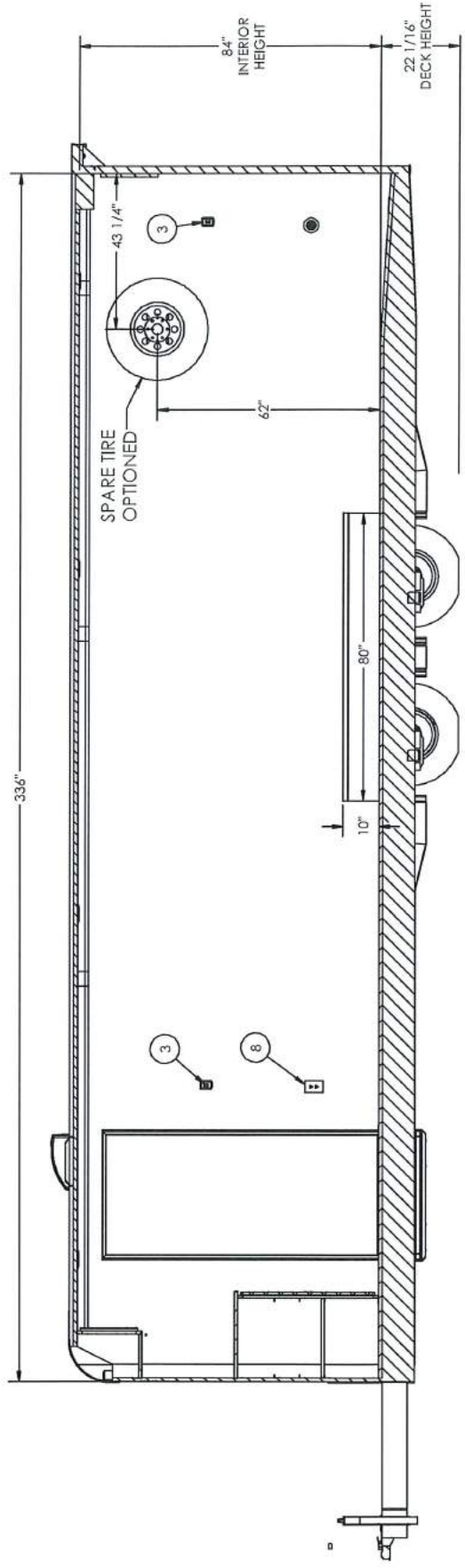

INTERIOR CURBSIDE



TITLE: 28 FT RCL - RAVEN LIMITED CH		REV.
DRAWN BY: DATE	VN/PART #	
HRM	05/07/21	Marketing
FILE NAME: CJS, AL - Car Hauler 2021 - Raven - 28 ft Marketing		
SCALE: 1:64	DATE PRINTED: 5/25/2021	SHEET 2 OF 6

CABINET PACKAGE 3 SHOWN.
REFER TO CABINET PRINTS FOR
OTHER CABINET OPTIONS.

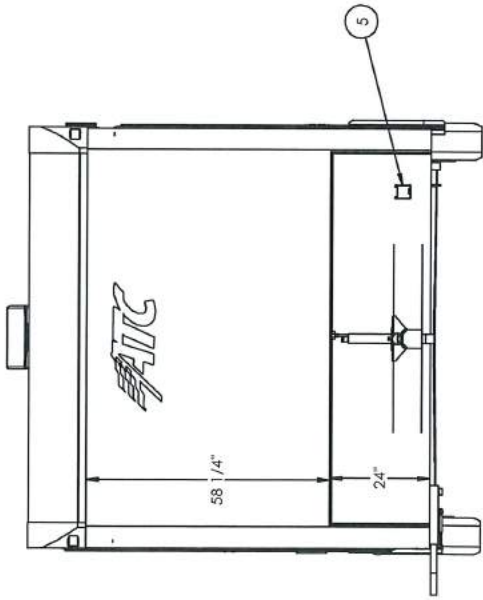

EXTERIOR FRONT

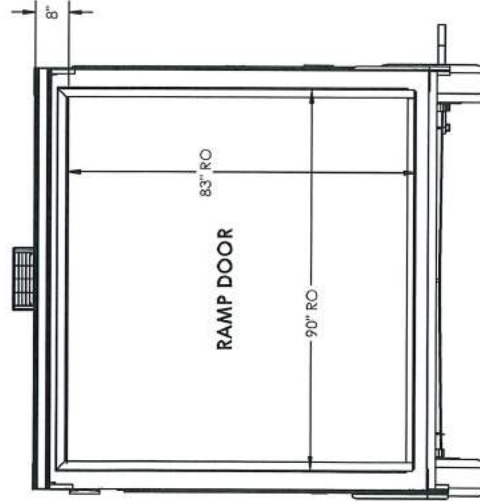

EXTERIOR REAR

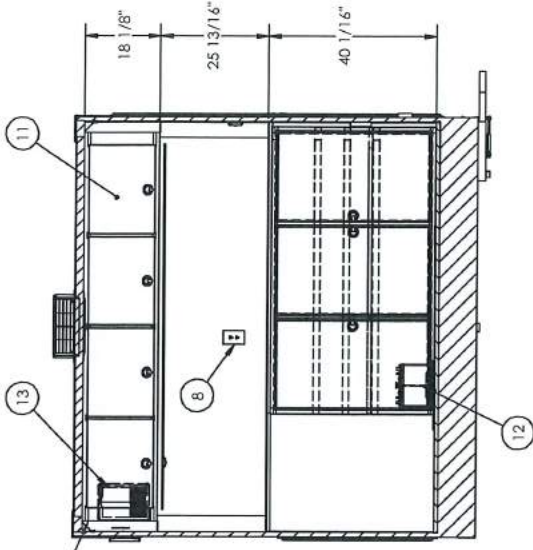

INTERIOR FRONT

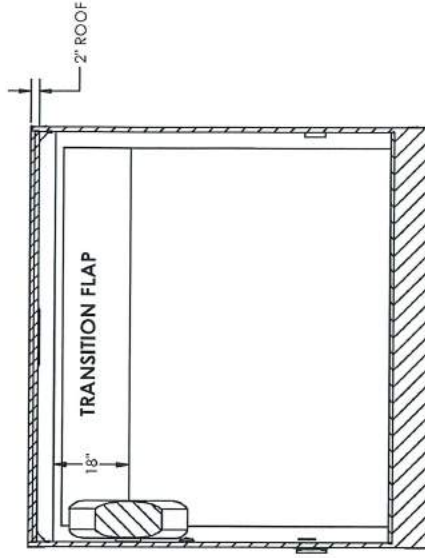

INTERIOR REAR



TITLE: 28 FT RCL - RAVEN LIMITED CH			
DRAWN BY: HRM	DATE: 05/07/21	VIN/PART # Marketing	REV.
FILE NAME: CUS_AL - Car Hauler 2021 - Raven - 28 ft Marketing			
SCALE: 1:64	DATE PRINTED: 5/25/2021	SHEET 3 OF 6	

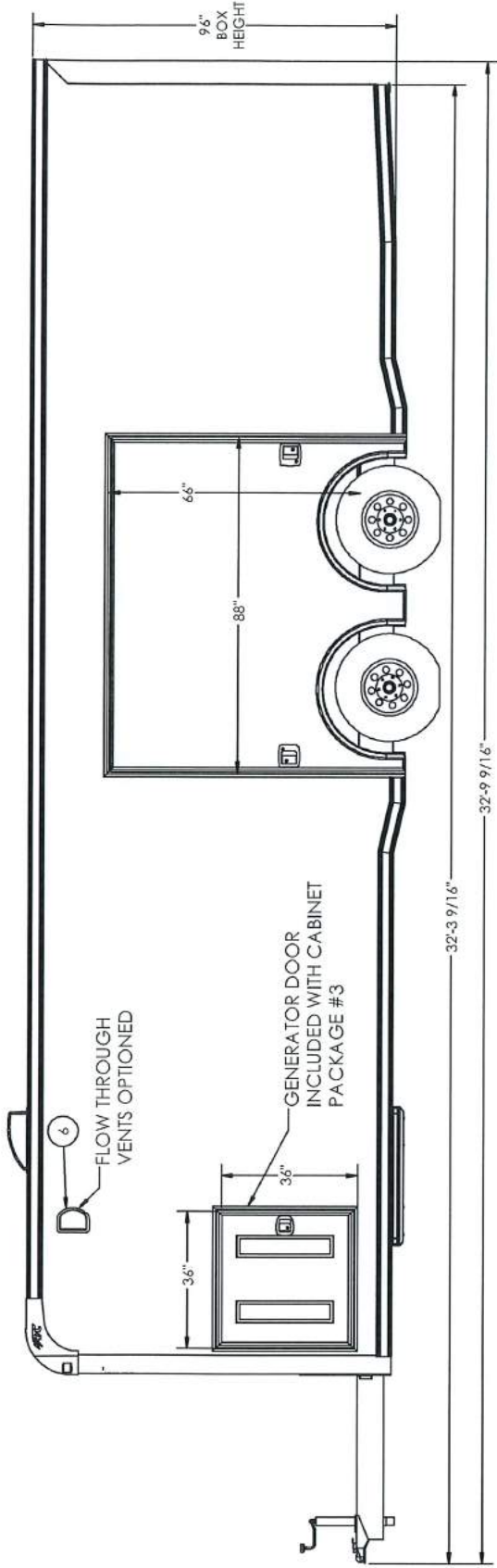

EXTERIOR ROAD SIDE

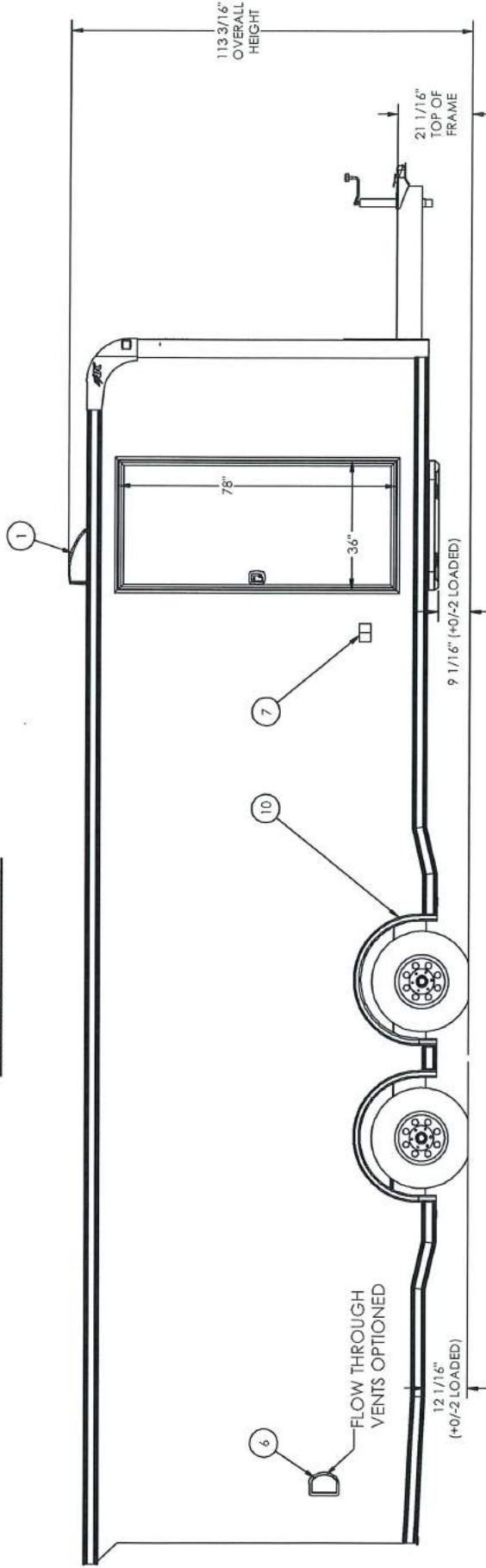

EXTERIOR CURB SIDE



TITLE: 28 FT RCL - RAVEN LIMITED CH	
DRAWN BY: HRM	DATE: 05/07/21
FILE NAME: CUS_AL - Car Hauler 2021 - Raven - 28 ft Marketing	REV. Marketing
SCALE: 1:64	DATE PRINTED: 5/25/2021
SHEET 4 OF 6	



ROAD SIDE VIEW

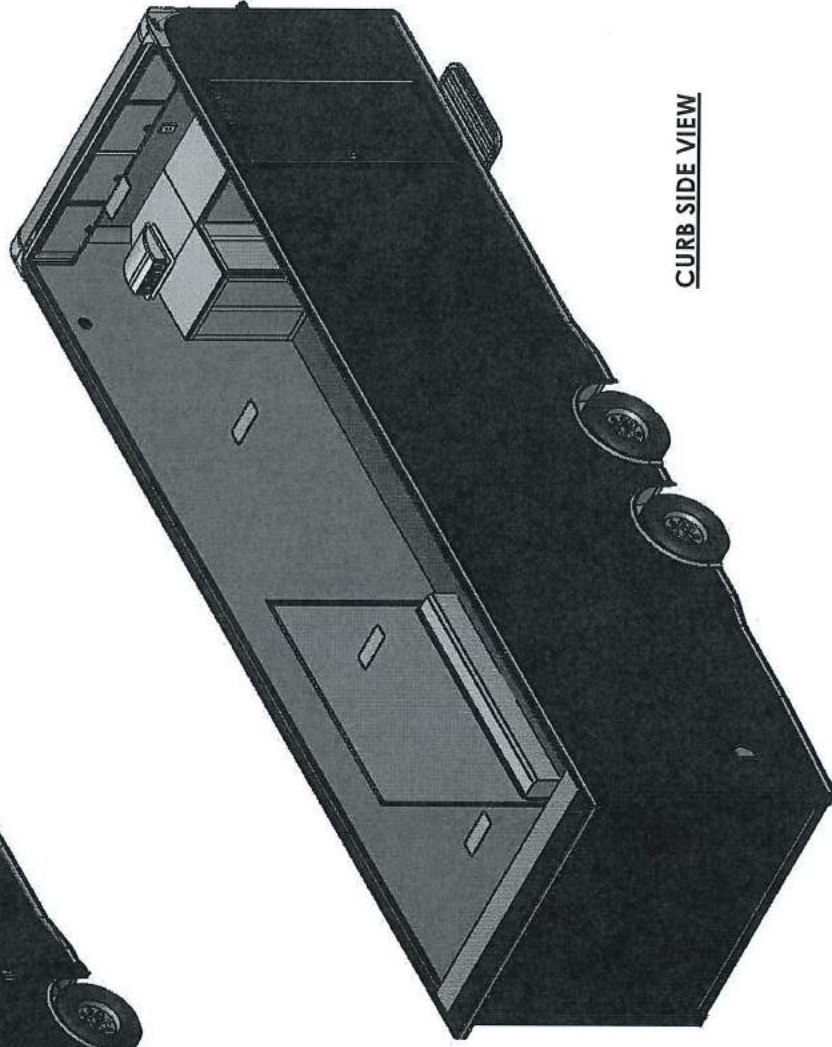

CURB SIDE VIEW



TITLE:	28 FT RCL - RAVEN LIMITED CH		
DRAWN BY:	DATE:	VIN/PART #	REV.
HRM	05/07/21	Marketing	
FILE NAME:	CUS_AL - Car Hauler 2021 - Raven - 28 ft Marketing		
SCALE:	1:28	DATE PRINTED:	5/25/2021
			SHEET 5 OF 6

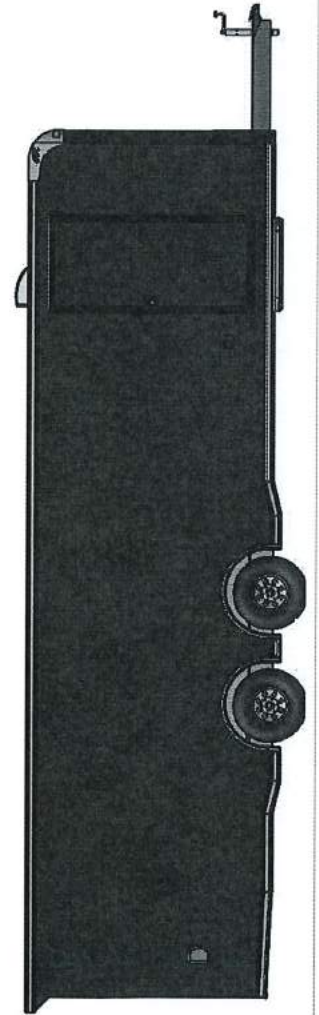
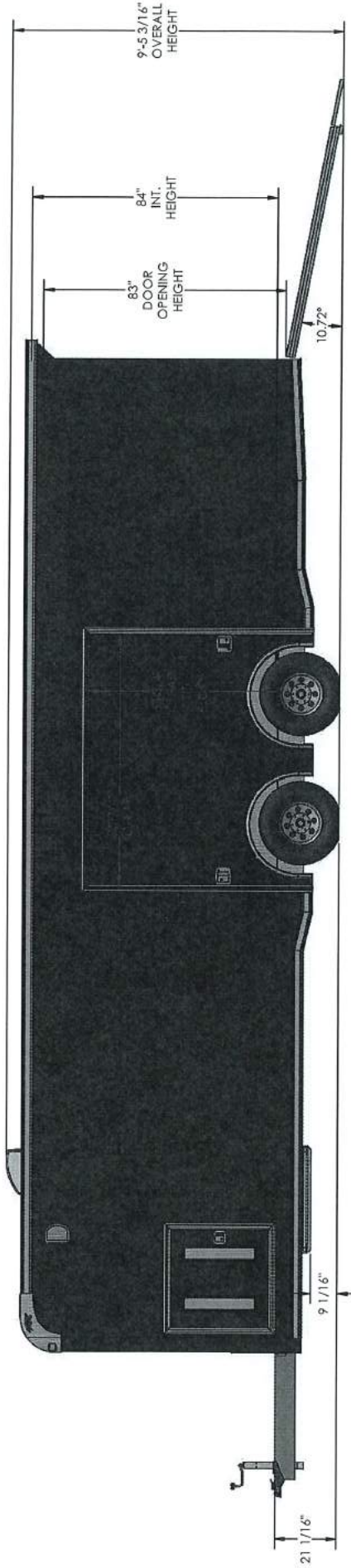
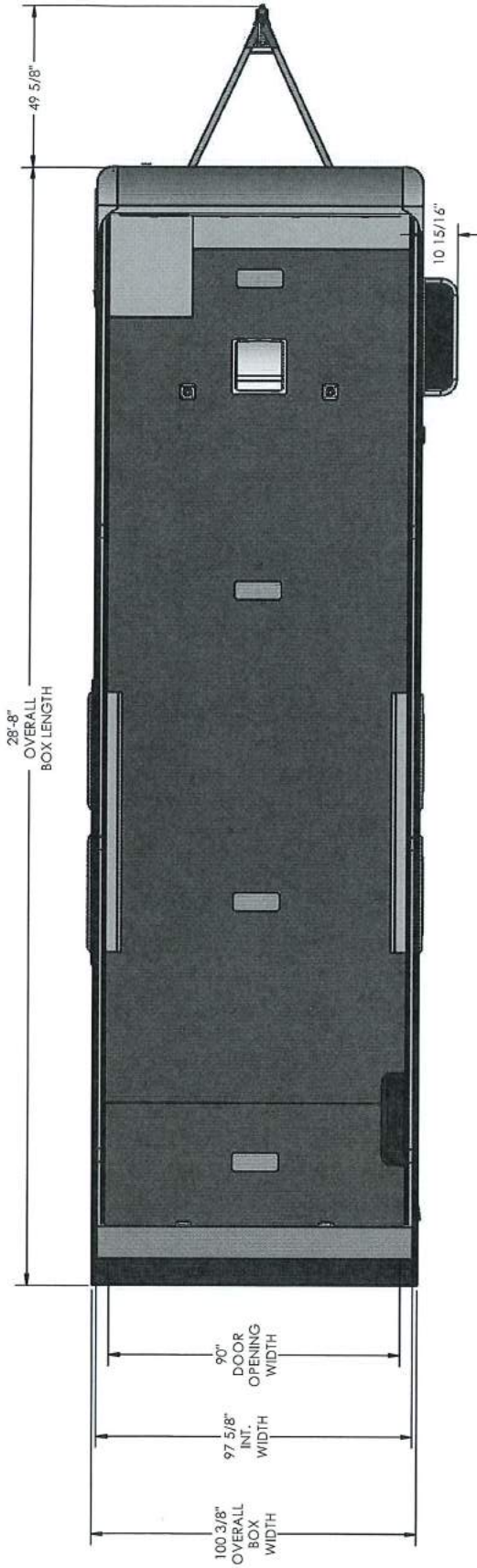

TITLE: 28 FT RCL - RAVEN LIMITED CH			
DRAWN BY:	DATE:	VIN/PART #	REV.
HRM	05/07/21	Marketing	
FILE NAME: CUS, AL - Car Hauler 2021 - Raven - 28 ft Marketing			
SCALE: 1:26	DATE PRINTED: 5/25/2021	SHEET 6 OF 6	